

29384

Dimensions

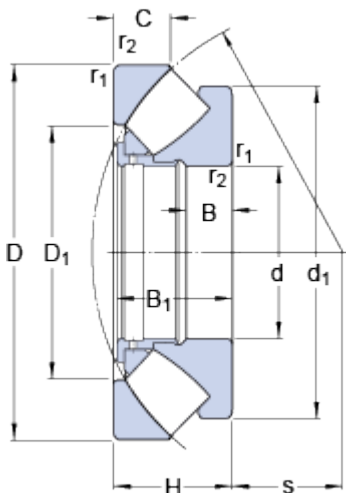

d	420	mm
D	650	mm
H	140	mm
d ₁	≈ 626	mm
D ₁	≈ 520	mm
B	49	mm
B ₁	135	mm
C	67.5	mm
s	235	mm
r _{1,2}	min. 6	mm

Abutment dimensions

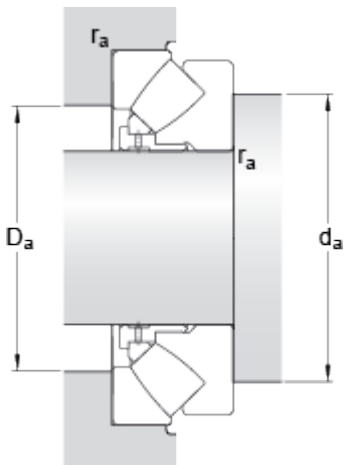

d _a	min. 535	mm
D _a	max. 580	mm
r _a	max. 5	mm

Calculation data

Basic dynamic load rating	C	3740	kN
Basic static load rating	C ₀	16000	kN
Fatigue load limit	P _u	1290	kN
Reference speed		500	r/min
Limiting speed		900	r/min
Minimum axial load factor	A	24	

Mass

Mass bearing		170	kg
--------------	--	-----	----